

Vario

User manual



The Wellness Company

Contents

Contents.....	2
Important safety instruction	3
Personal safety	5
Manufacturer and equipment identification	7
Description of the equipment.....	8
Technical data.....	9
Accessories	13
Safety devices and warnings	14
Place of usage	16
Moving the equipment	17
Levelling.....	19
Electrical connection (mains powered version).....	20
Connection to another device.....	23
Routine maintenance	25
Changing the fuses (mains powered version and Renew)	26
Recharging the battery (battery-powered version).....	27
Troubleshooting.....	28
Technical assistance	30
Storage	31
Disposal	32
Switching on and off.....	33
Monitoring the heart rate	35
Using the equipment	38

Important safety instruction

You should always consult with a qualified and licensed medical professional or healthcare practitioner before starting any nutritional, diet, stretching or exercise program. You are advised to investigate and inform yourself about any health related actions and choices you make.

Please read all instructions before using the equipment. These instructions were written to ensure your safety and to protect the unit.

When using an electrical appliance, basic precautions should be always followed, including the following.



DANGER

To reduce the risk of electric shock, always unplug the unit from the electrical outlet immediately after using and before cleaning or performing any maintenance tasks.



WARNING

To reduce the risk of burns, fire, electric shock or injury to person, take the following precautions.

The equipment should never be left unattended when plugged in. Unplug from outlet when not in use, before cleaning it, and before putting on or taking off electrical parts.

Do not allow unsupervised children close to the equipment.

Close supervision by qualified personnel is necessary when the equipment is used by or near children, invalids or disabled persons.

Use the equipment only for its intended use as described in the user manual. Only perform the exercises for which the equipment has been designed, following the instructions given in the manual. Any other use is to be considered improper and therefore dangerous.

Do not use attachments not recommended by Technogym.

Never operate the equipment if it has a damaged cord or plug, if it is not working properly, if it has been dropped or damaged, or dropped into water. In this case, contact the Technogym Technical Support service.

Do not carry the equipment by supply cord or use cord as handle.

Important safety instruction

Keep the cord away from heated surfaces.

Keep hands and feet away from moving parts.

Never drop or insert any object into any opening.

Do not use outdoors. Do not leave the equipment outdoors, exposed to the elements (rain, sun, wind, etc.). Do not expose the equipment to water jets.

Do not operate where aerosol (spray) products are being used or where oxygen is being administered.

To disconnect, turn all controls to the off position, then remove plug from outlet.

SAVE THESE INSTRUCTIONS



WARNINGS

Do not connect a device with load exceeding 7A.

Risk Of Electric Shock. Do Not Disconnect Under Load.

Do not connect to a circuit operating at more than 150V to Ground.

Personal safety

Use of the equipment is subject to a medical examination in relation to the intended type of exercise, and compliance with the conditions of use laid down by the manufacturer.

Persons suffering from certain physical conditions may only use the equipment under the strict supervision of a specialist doctor.

If, during exercise, the message “HIGH HEART RATE” appears, your heart rate is too high and you should **slow down** the exercise.

Before starting an exercise, make sure **your position** on the equipment is correct, and be careful with any components that might constitute an obstruction.

Choose suitable exercises for your physical characteristics and state of health, starting out with light loads.

Do not overexert yourself or work to exhaustion. Incorrect or excessive exercise may cause serious physical harm or even death. If you feel any pain or abnormal symptoms, stop your workout immediately and consult your physician.

Wear proper exercise clothing and shoes during a workout, no loose clothing. Tie long hair back. Keep garments or towels away from moving parts.

During use people must remain at a safe distance.

Do not use the equipment in presence of small children or pets.

The person in charge of the gym must explain to the users about proper and improper use of the equipment.

Completely assemble the equipment before using it. Check the equipment before each use. Do not continue to operate the equipment when it is not working properly.

Assemble and operate the equipment on a solid, level surface.

Keep all electrical components, such as the power cable and I/O switch, away from liquids to prevent shock.

Maintain the equipment in good working condition. If there are signs of wear, contact the Technogym Technical Support service.

Do not attempt to service the equipment yourself other than the maintenance instructions found in the user manual.

The installation, maintenance and setting must be done by qualified Technogym staff or persons authorised by Technogym.

The electrical system must conform to the standards and legal requirements in the country of use.

Personal safety

Do not set anything on the casing or control panel.

Technogym is not responsible for any damages due to any failures or damage caused by unauthorized service, misuse, accident, negligence, improper assembly or installation, debris resulting from any construction activities in the product's environment, rust or corrosion as a result of the product's location, alterations or modifications without Technogym's written authorization or for failure on your part to use, operate and maintain the products as set out in this User Manual.



WARNING

There are high voltages inside the equipment, therefore the guard must be removed by authorised personnel only.

Manufacturer and equipment identification

- A** - Manufacturer's name and address
- B** - Place of manufacture
- C** - Description of product
- D** - Electrical specifications
- E** - Tells you to consult the User manual
- F** - Serial number and date of manufacture
- G** - Product model

The Vario is a commercial device, designed for use in residential and professional environments. It is a class SA device, pursuant to ISO EN 20957-1.

The values stated in the illustration are purely indicative; refer to the label attached to the equipment or the data in "Technical data" section for the correct information.

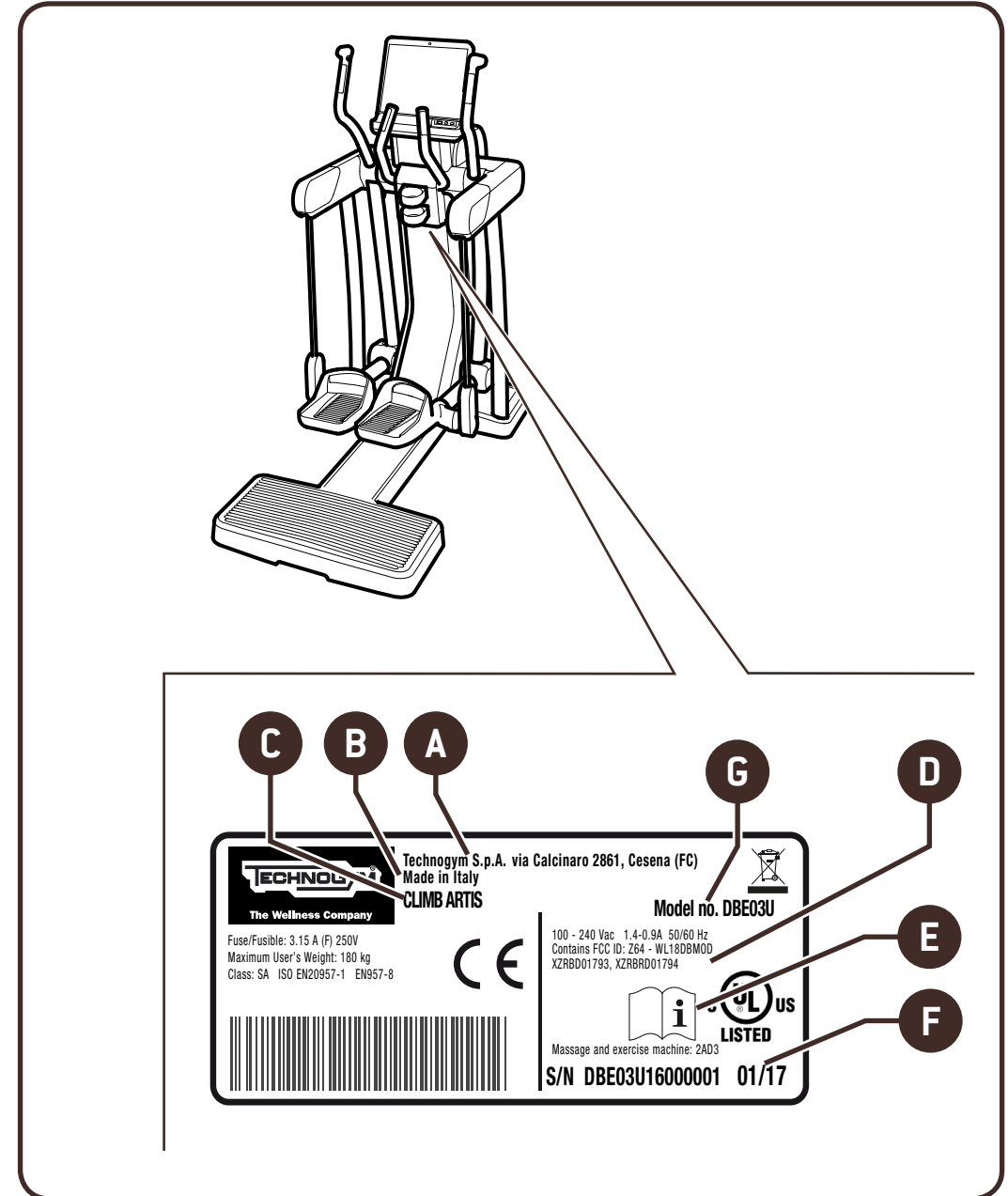

Description of the equipment

Control panel (A): it allows you to view and control information, settings and contents both for workouts and for entertainment. The tablet-style touch screen interface allows you to include the contents offered by the Technogym App Store. Please see the control panel's manual to see how it works.

Object holder (B): for standing the water bottle or other useful items on during the workout.

Levers (C): they are gripped during the exercise to combine training of legs and arms.

Fixed handgrips (D): they are gripped when working out only with legs.

Side supports (E): to guarantee stable and safe access.

Hand sensor (F): for constant heart rate monitoring.

Fast Track Control (G): they allow users to change the level of intensity of the exercise without removing their hands from the levers, ensuring a correct and safe posture.

Platforms (H): the specific shape of the platforms means that the user's ankles are exercised in optimum conditions.

Water bottle holder (L): where you can place water bottles during workout.

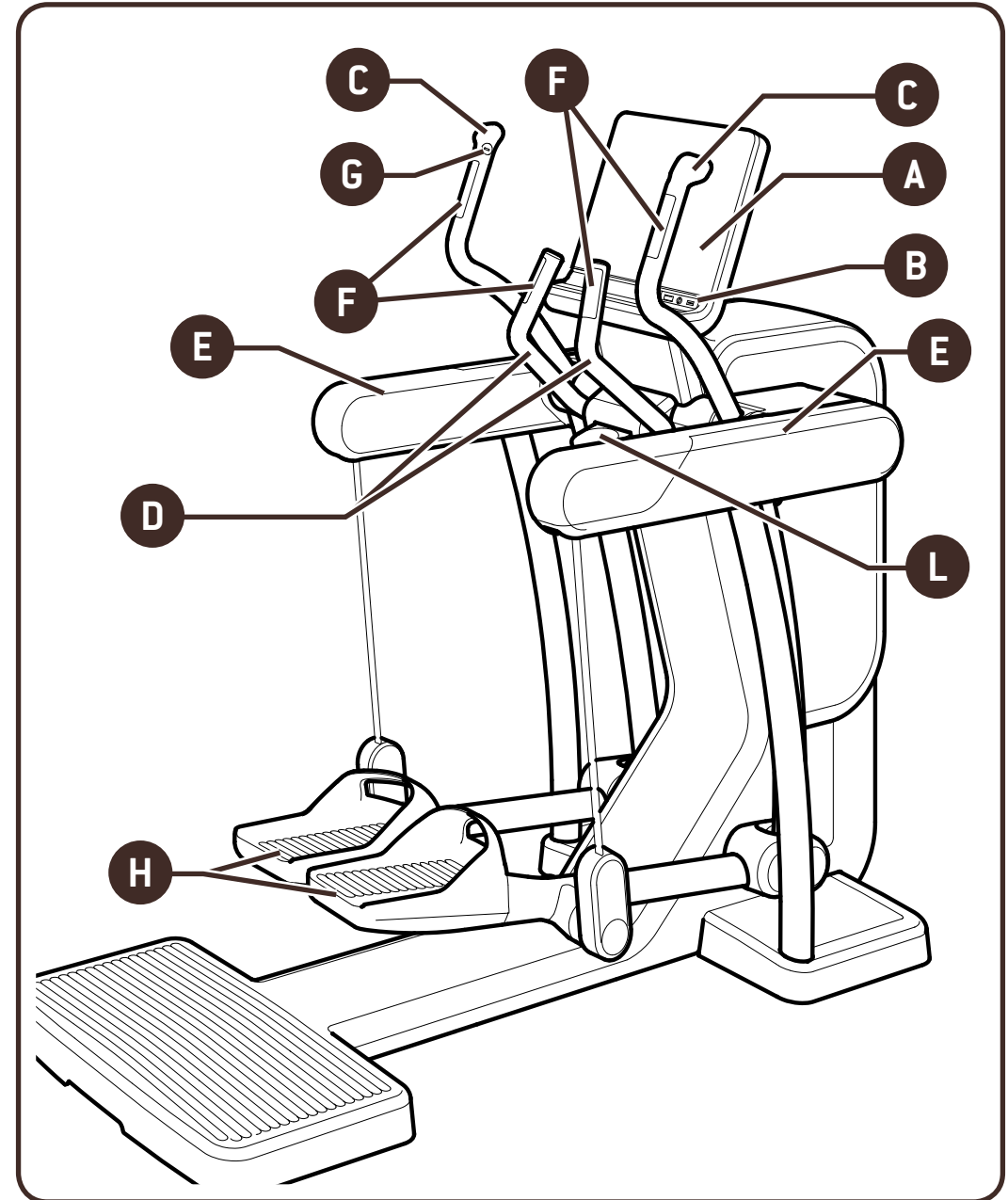

Technical data

	Mains powered Vario	Battery-powered Vario
Power supply	100÷240 Vac 50/60 Hz	-
Mains power input	100 VA max (160 VA max with Unity)	-
Fuses	2 x 3,15A (F)	-
Braking power (130 spm)	3310 W ± 10%	390 W ± 10%
Weight of equipment	200 kg (441 lb)	200 kg (441 lb)
Maximum user weight	160 kg (352 lb)	160 kg (352 lb)
Time	0÷999 min ± 1%	0÷999 min ± 1%
Distance	0÷99.99 km ± 5% (0÷99.99 mls ± 5%)	0÷99.99 km ± 5% (0÷99.99 mls ± 5%)
Protection grade	IP 20	IP 20
Electric isolation class	Class I	Class I
Noise level	Less than 70 dB (A)	Less than 70 dB (A)

Adjustable braking system; power depends on the level set and speed.

Technical data

	Vario Renew - Europe	Vario Renew - USA
Power supply	100-240 VAC ± 10% 50/60 Hz	120 Vac ± 10% 60 Hz
Rated output voltage	230 VAC	100-120 VAC
Rated voltage	230 VAC	100-120 VAC
Rated output current	0-1.4 A	0-3 A
Maximum output current	1.43 A @ 330 W	3 A @ 330 W
Maximum apparent power	3.3 var	3.3 var
Rated apparent power (peak generated power)	330 W	330 W
Maximum cosφ	0.98	-
Minimum cosφ	-0.98	-
Short circuit current	7 A	7 A
Transient connection current	0 A	0 A
Direct current generation in the event of faults	<0.25% of the rated output current	<0.25% of the rated output current
Fuses	2 x 3.15A (F)	2 x 3.15A (F)
Weight of the equipment	200 kg (441 lb)	200 kg (441 lb)
Maximum user weight	160 kg (352 lb)	160 kg (352 lb)
Time	0 - 999 min ± 1%	0 - 999 min ± 1%
Distance	0 - 99.99 km ± 5%	0 - 99.99 km ± 5%
Degree of protection	IP 20	IP 20
Class of electric insulation	Class I	Class I

Technical data

	Vario Renew
Minimum resistance at 480 spm	30 W
Maximum resistance at 130 spm	401 W

Technical data

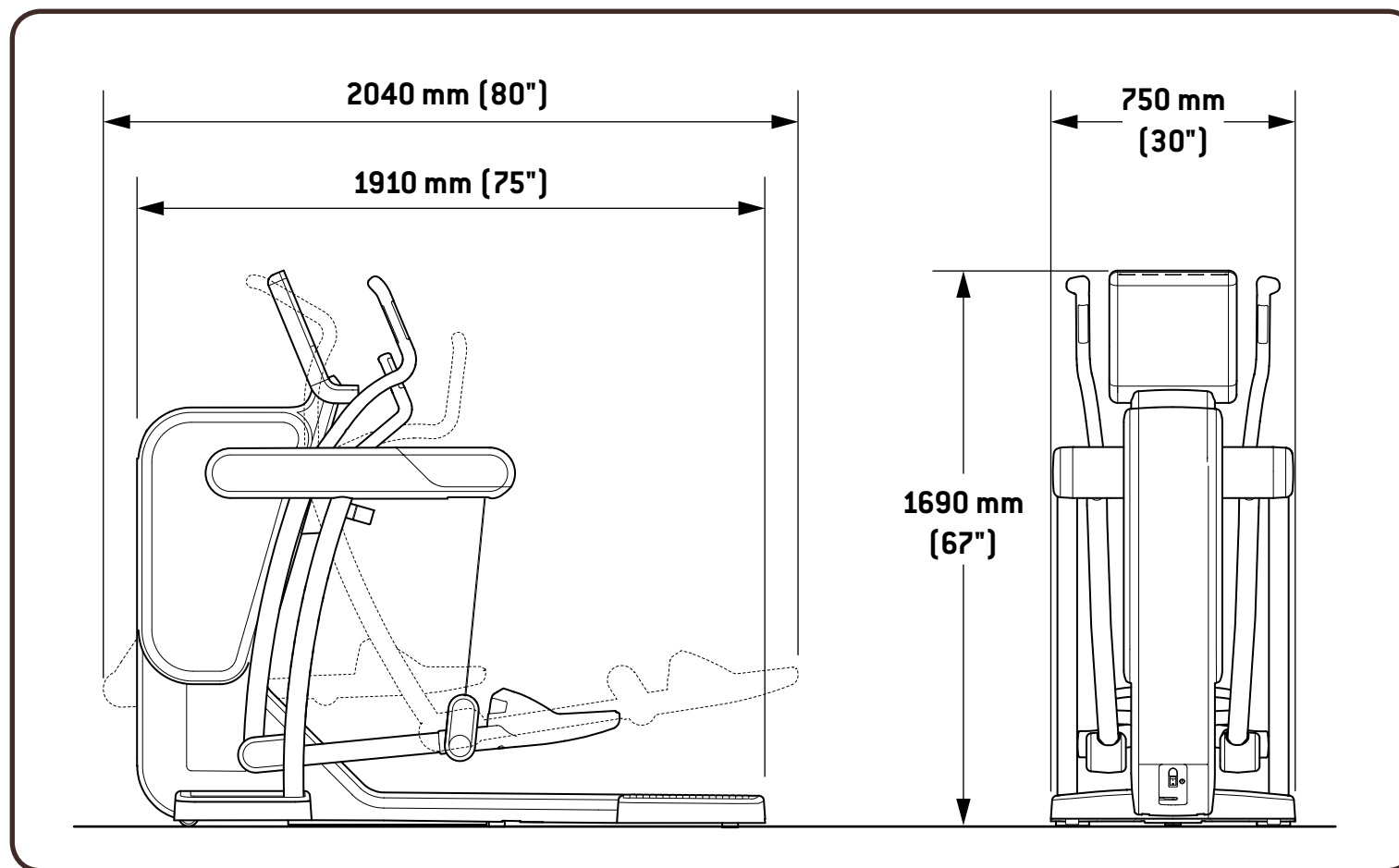

Accessories

The equipment's standard outfit comprises:

- A Set of wrenches
- B User manual
- C Warranty certificate
- D CEE Power Supply cable with SH socket
- E Cloth for cleaning
- F Two replacement fuses (2 x 3.15A (F))

The charger comes with the battery-powered version.

Charger electrical specifications:

Input 100÷240 Vac 0,8 A 50/60 Hz
Output 15 V dc 24W \ominus \oplus
Class II

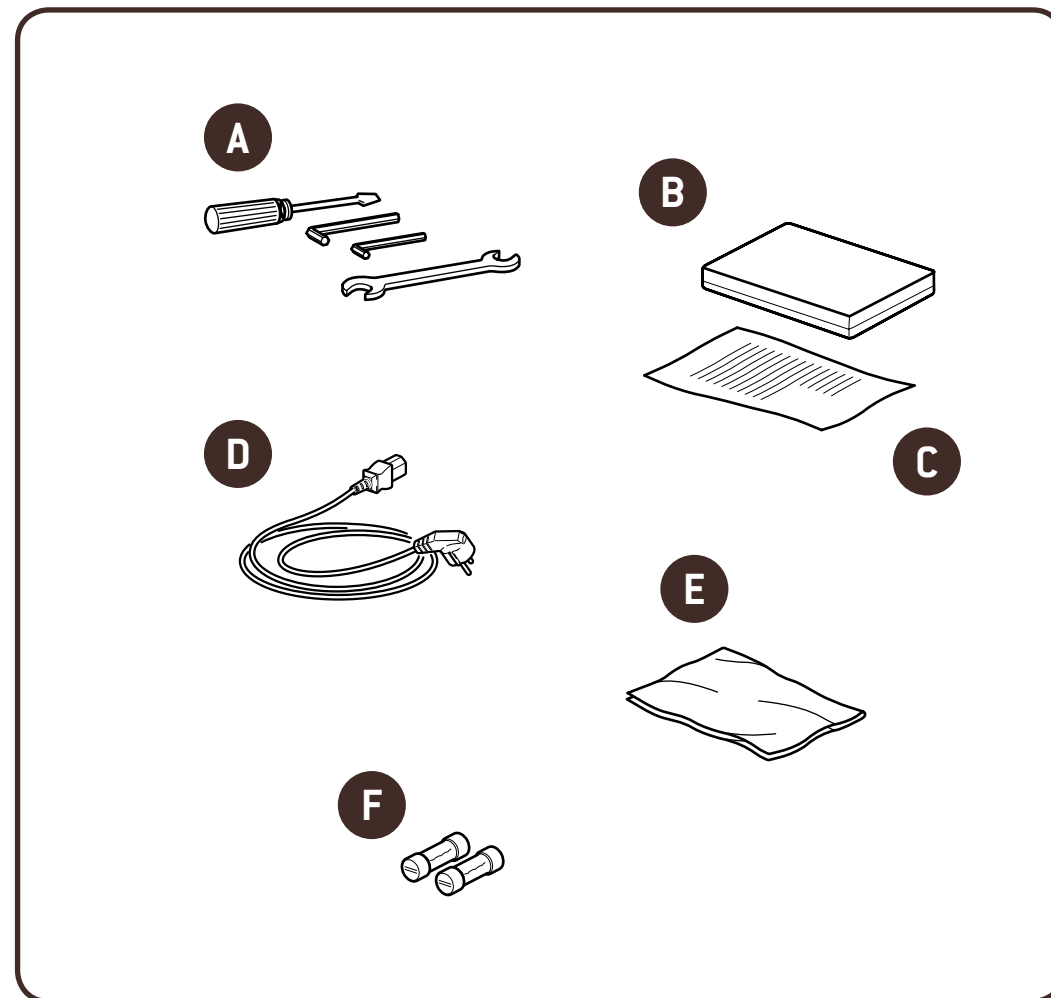

Safety devices and warnings

In all versions:

A Fixed guard: guards against access to the inside of the equipment.

In the mains powered version:

B Main switch: turns the equipment's power on and off.

C Fuses: they protect the equipment's electrical parts. When the current reaches an excessive value, the fuses melt thus protecting the internal electronics.

Open panel (D) to reach the fuses: put a finger in the hole and pull.

In the battery-powered version the main switch (B) connects or disconnects the battery to preserve it.

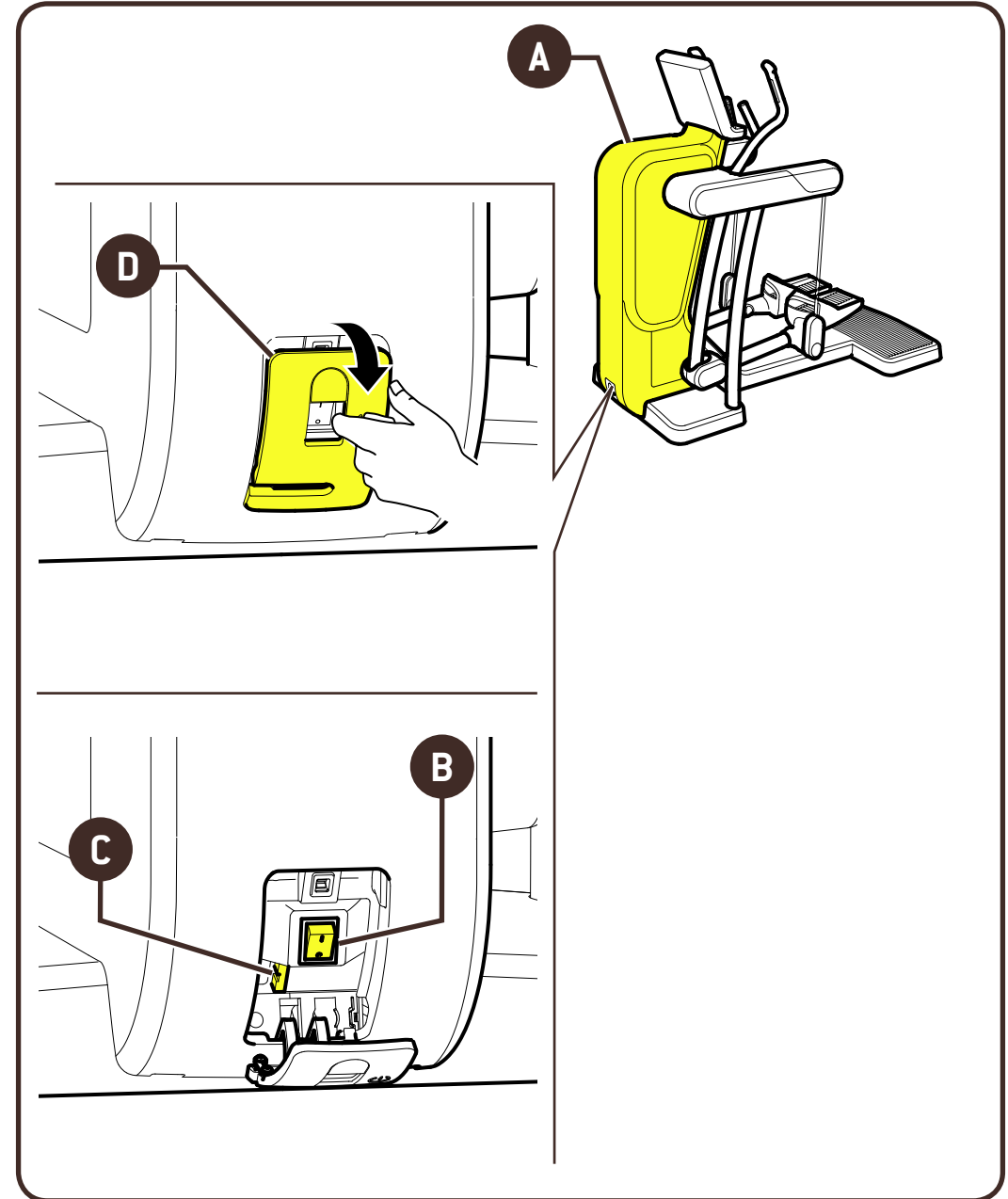

Safety devices and warnings

- E The label affixed close to the main switch states the electrical specifications and safety indications.
- F The label which can be affixed to the power supply cable states the electrical specifications for the cable.



WARNING

Please read the adhesive labels on the equipment, which provide information about possible risks and hazards.

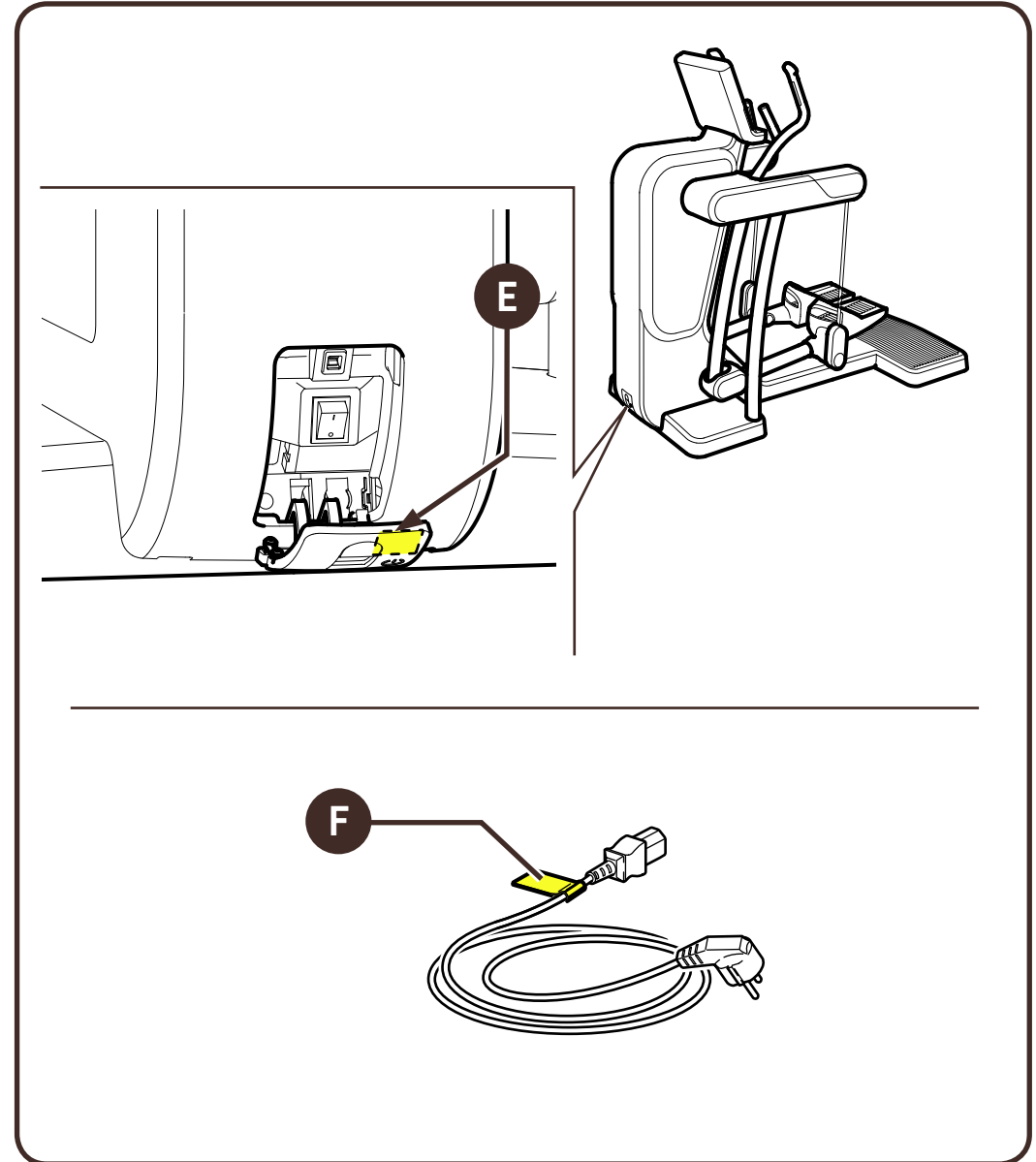

Place of usage

To ensure that exercising with the equipment is easy, safe and effective, the place where it is used should comply with certain specific requirements; in particular, before choosing the place where the equipment will be installed, please ensure that the following conditions are satisfied:

- the **temperature** is between +10°C and +25°C;
- enough air is circulating to keep **humidity** during exercise to between 20% and 90%;
- the **lighting** is good enough to make the area safe and relaxing place to exercise in;
- **free space** of at least 60 cm around the entire perimeter of each product;
- the floor is flat, stable and vibration-free, and strong enough to bear the weight of the equipment plus user.

Do not expose the equipment to direct sunlight.

Do not install the equipment in areas with high humidity levels, for example close to swimming pools, whirlpools or saunas.

The place of installation must comply with all the suitability requirements laid down in current legislation on this matter.

ARTIS RENEW

Since the equipment in the Artis Renew line are classed as renewable energy generation systems and their users are "active users", the owner of the equipment must apply to the local electricity distributor for the appropriate contract agreements, **before** connecting the equipment to the electrical system. Technical and commercial details of the equipment depend on the Country or Region where they are installed.

The local electricity distributor may require the installation of a bi-directional meter, to meter the quantity of electricity exchanged between the equipment of the Artis Renew line and the electricity distribution network.

Moving the equipment



WARNINGS

Take great care when moving the equipment, as it may overbalance.

When lifting or moving the equipment, do not take hold of the platforms, levers or the control panel as hand holds.

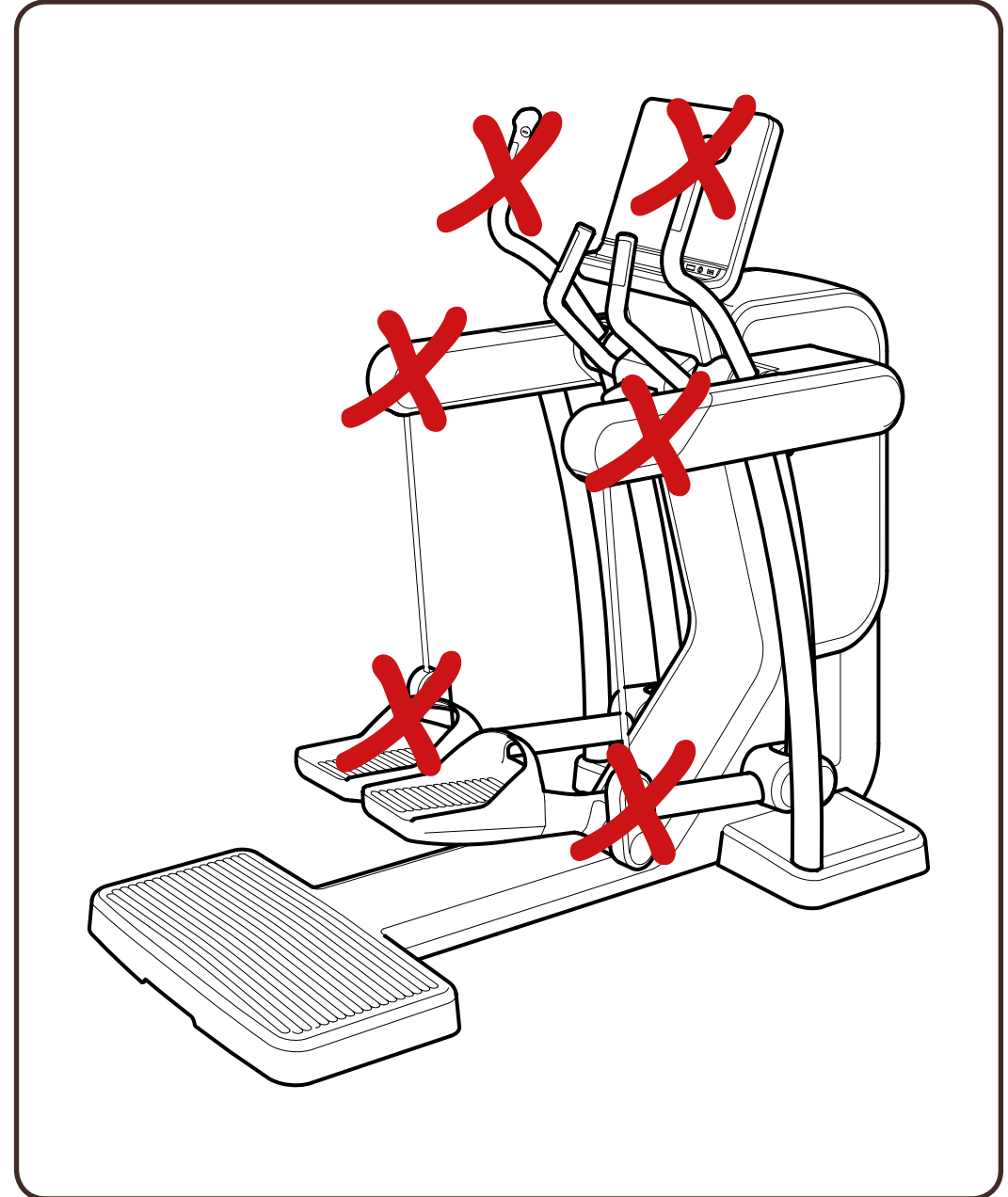

Moving the equipment

The equipment has fixed front wheels. To move the equipment, lift it up slightly, gripping the metal part under the plastic platform, as shown in the illustration, and push it forwards and backwards.

Given the weight of the equipment, we recommend that more than one person be involved in moving it.

If wheels cannot be used on the floor, move the equipment with normal lifting and transport methods.

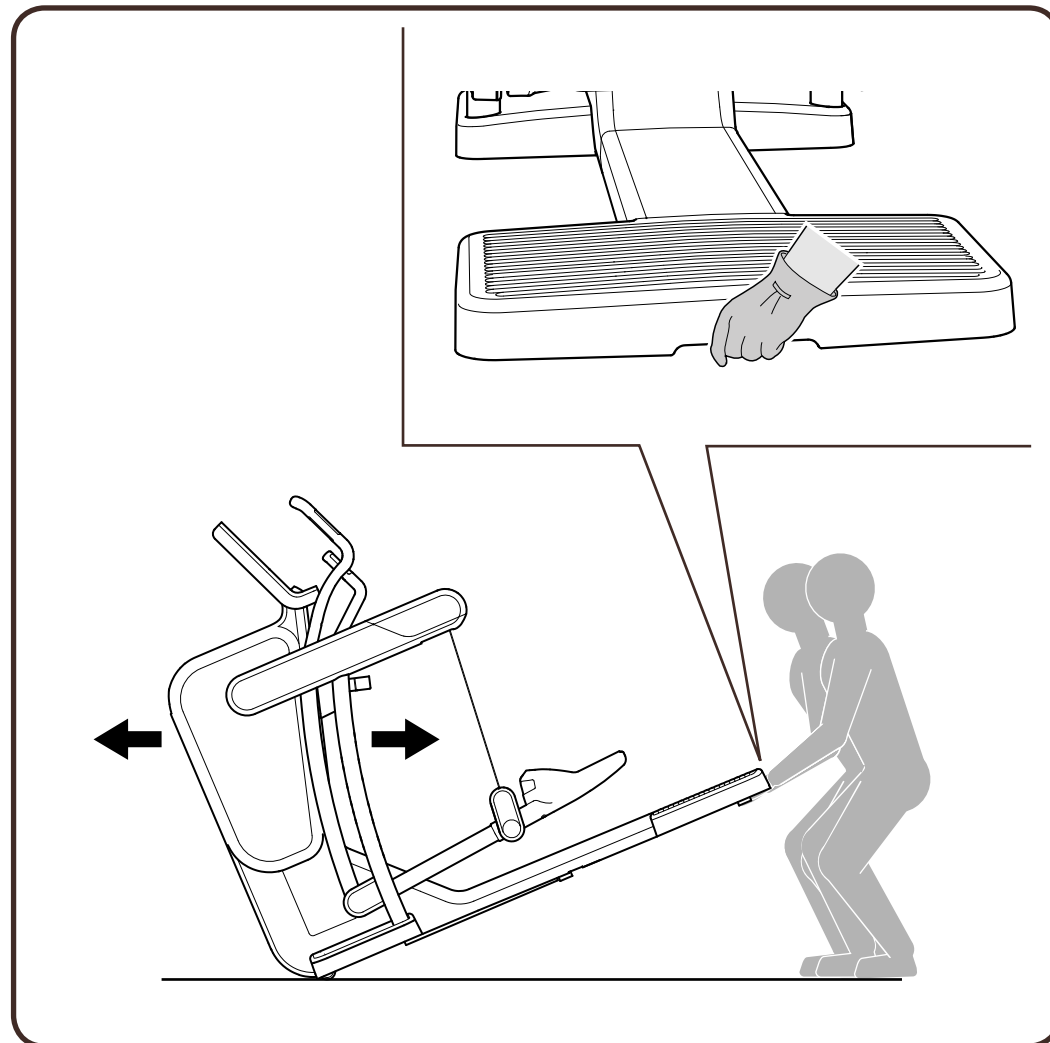

Levelling

Use the three feet shown in the illustration to level the equipment:

- loosen the lock nut (**B**);
- screw the front feet (**A**) in or out until the frame is in a stable position;
- tighten up the lock nut (**B**) after adjusting.

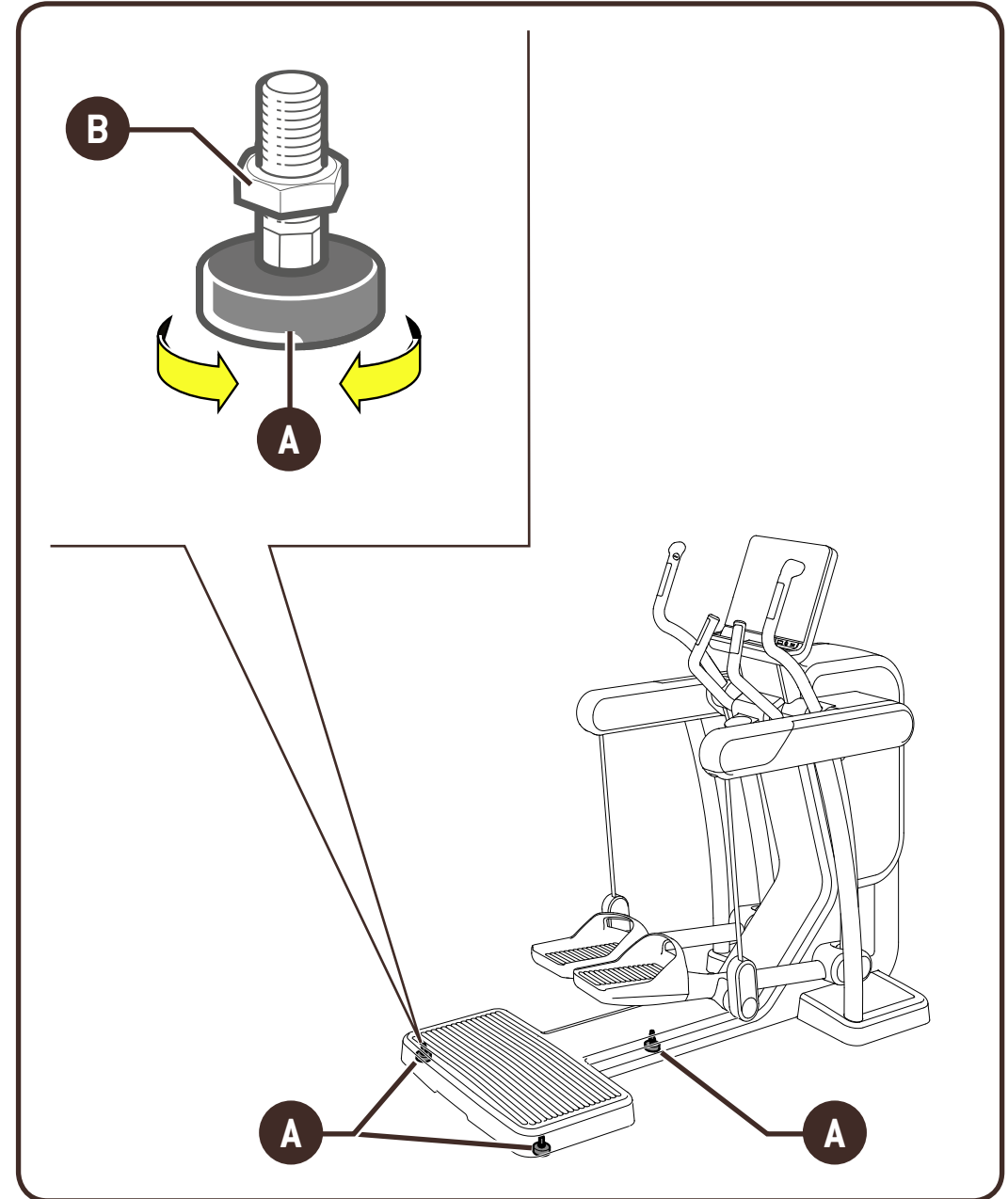

Electrical connection (mains powered version)

Before connecting the equipment to the mains power supply, ensure that the electrical system specifications comply to binding regulations. Verify the main power supply specifications on the label affixed close to the main switch.

Open panel (A) to reach the label and connector: put a finger in the hole and pull.



WARNINGS

The wall socket must be located in a place where the plugging and unplugging can be done easily and safely.

When plugging in, the switch on the equipment must be in the 0 position (i.e. the equipment must be switched off).

Plug the power cable first into the equipment socket and then into the wall socket.

Close panel (A) putting the cable through the slot.

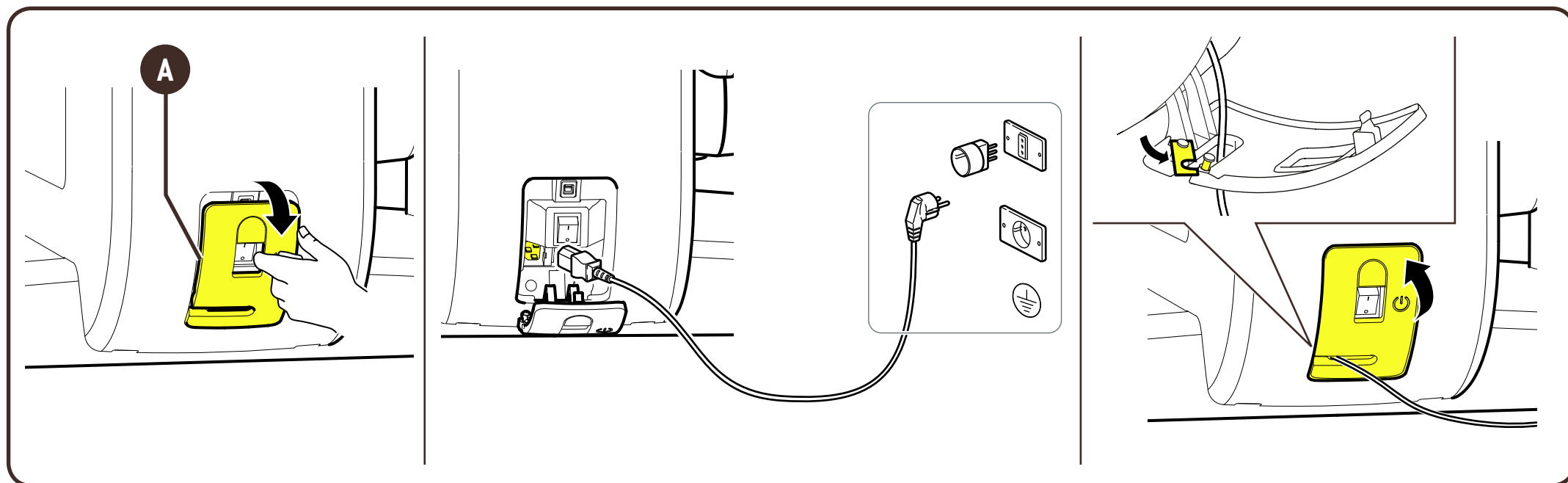

Electrical connection (mains powered version and Renew)



WARNING

Check the state of the power supply cable periodically.

The power supply socket must be grounded . If not, a ground connection must be installed by a qualified electrician before connecting the equipment to the electricity mains.

The product must be grounded. If it should malfunction or breakdown, grounding provides a path of least resistance for electric current to reduce the risk of electric shock. The product is equipped with a cord having an equipment-grounding conductor and a grounding plug. The plug must be plugged into an appropriate outlet that is properly installed and grounded in accordance with all local codes and ordinances.



WARNINGS

Improper connection of the equipment-grounding conductor can result in a risk of electrical shock. Check with a qualified electrician or serviceman if you are in doubt as to whether the product is properly grounded. Do not modify the plug provided with the product; if it will not fit in the outlet, have a proper outlet installed by a qualified electrician.

ARTIS RENEW

Artis Renew is a line of cardio training equipment that is able to convert the mechanical energy produced by users when exercising into electric energy. This electric energy produced by exercising is input directly and in real time into the electricity distribution network to which the equipment is connected.

The electric energy produced by Artis Renew is processed so that it corresponds to the specifications of the electricity distribution system to which the equipment is connected.

Each item of Artis Renew line equipment is fitted with an internal system of electrical protection which guarantees the safety of the equipment and the safety of the electricity distribution network.

The electric energy processing parameters (power and frequency difference) and those of the internal electrical protection system depend on the technical regulations and the laws in force in the Country or Region where the equipment is installed.

The equipment in the Artis Renew line are classed as renewable energy generation systems. Users of Artis Renew equipment are active users, since this system is able to operate in parallel with the electricity distribution network. This mode of operation makes it possible to:

- input electric energy, when the energy required by the equipment to operate is lower than that produced by the exercise;
- absorb electric energy, when the energy required by the equipment to operate is higher than that produced by the exercise.

Connection to another device

The equipment can be connected to an audio/video reception device such as the **Cardio Theater**, as well as to a network of devices conforming to the CSAFE protocol.



WARNING

The devices connected must comply with international standards.

Whoever connects additional equipment to the input or output signal ports is responsible for the system's conformity to existing laws and standards. Consult the technical support department or your local representative if you have any doubts.

This port is optional.

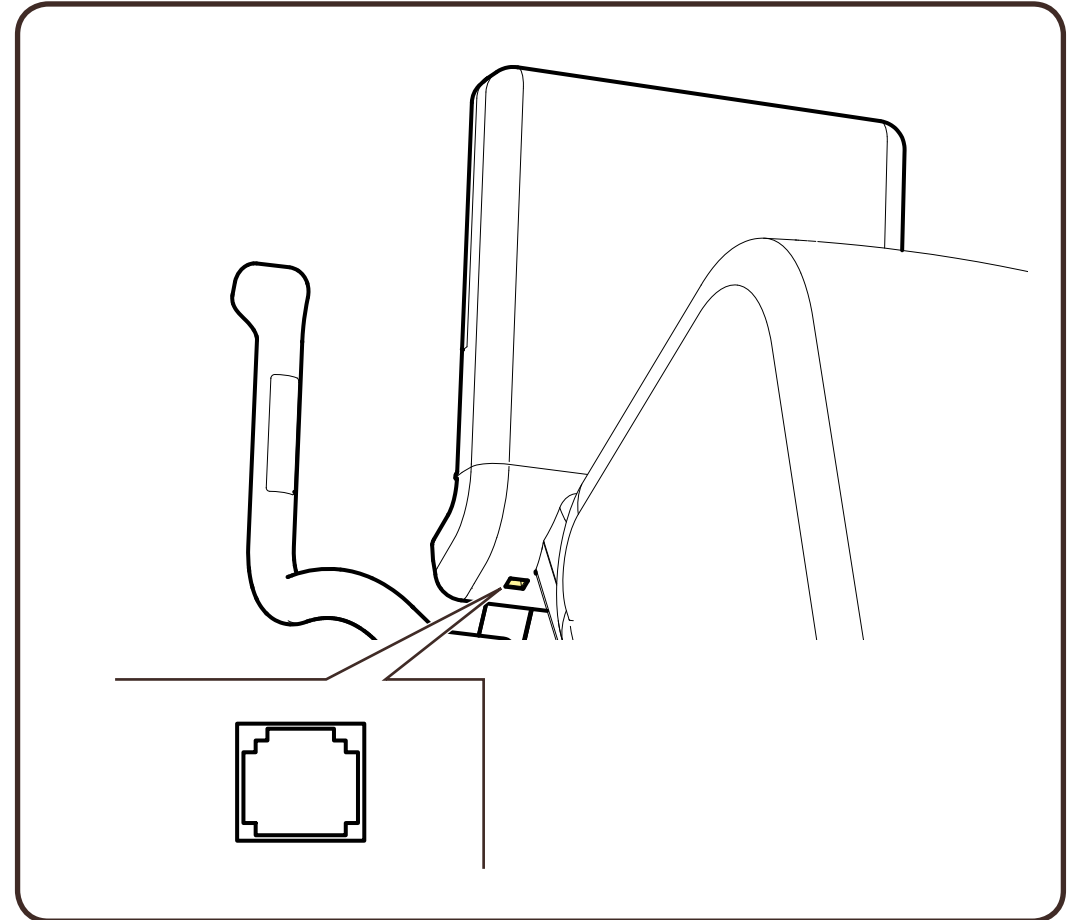

Connection to another device

If the equipment has TV, connect the aerial cable to the equipment and to the wall socket. Use an RF coaxial cable for the connection with an F type of connector for the equipment.

The wall socket of the aerial cable must be positioned so that the plug can be easily inserted and removed.

Open panel **(A)** to reach the aerial socket: put a finger in the hole and pull.

A network socket can be found next to the aerial socket for the Ethernet connection.

Close panel **(A)** putting the cables through the slot.

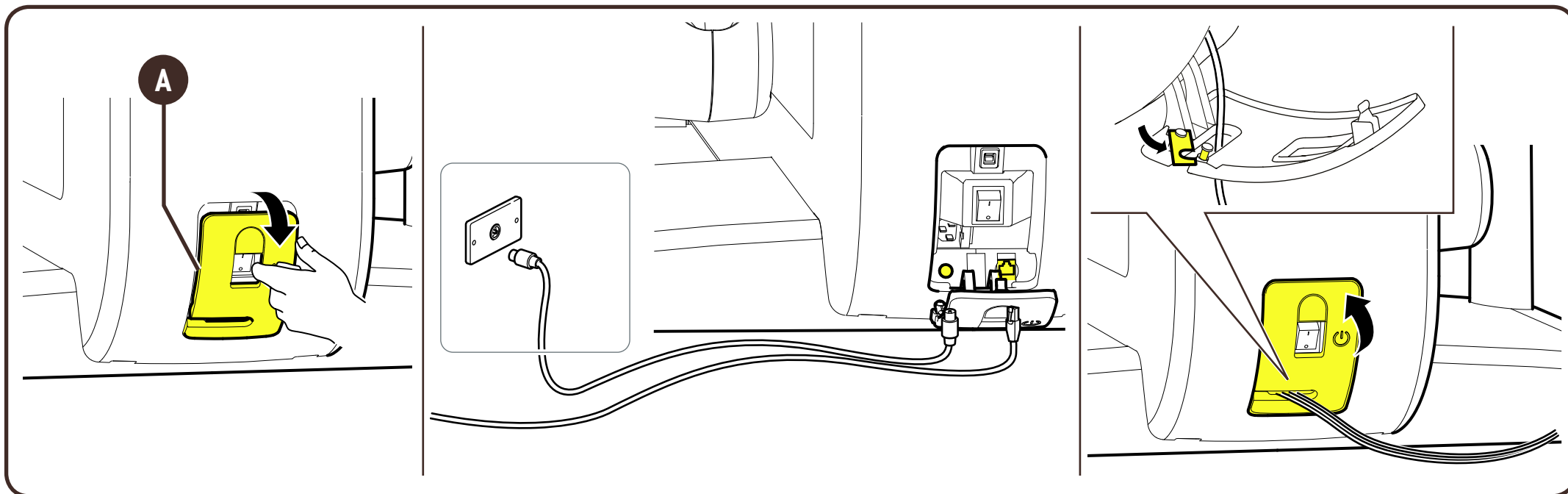

Routine maintenance

As the equipment is used in a sports centre by more than one person, it should always be kept clean and free of dust, in accordance with normal hygiene and sanitary rules.

To clean the **control panel**, proceed as follows:

- turn the equipment off by switching the switch to the **0** position;
- unplug the equipment power cable from the wall socket (mains powered version);
- clean the control panel with a damp, but not wet, cloth.

Every week, clean **the equipment completely**:

- turn the equipment off by switching the switch to the **0** position;
- unplug the equipment power cable from the wall socket (mains powered version);
- clean the external parts with a damp sponge.

Do not use chemical products or solvents.



WARNINGS

Do not rub too hard on the control panel and diagrams, or on the written instructions on the stickers.

The safety of the equipment is assured only on the condition that it is carefully inspected every two weeks for any signs of damage and/or wear.

For maintenance actions not described in this manual, call in the Technogym Technical Service.

Changing the fuses (mains powered version and Renew)



WARNINGS

The fuses must be changed by the Technogym Technical Support Service.

Before changing the fuses, switch the equipment off by switching the switch to 0 and unplug the power cable plug from the wall socket.

Open panel (A) to reach the fuses: put a finger in the hole and pull.

Remove the fuse holder, to the right of the switch, by pushing the lever.

Replace the blown fuse with a new one as supplied (3.15A (F)).

Fit the fuse holder back into its housing, making sure it clicks in properly.

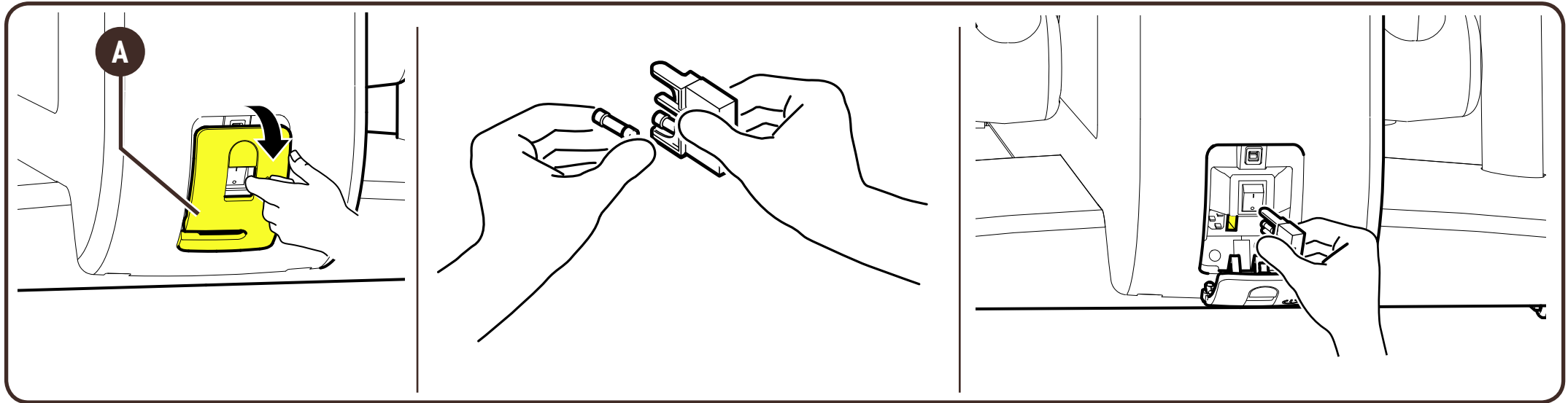

WARNING

If no more of the supplied fuses are available, use certified fuses with identical electrical specifications (3.15A (F)) for the replacement.

Recharging the battery (battery-powered version)

In the battery-powered version, the platforms must be kept in motion to ensure that the equipment remains switched on. If, when you stop moving the platforms, the control panel switches off without warning, check that the main switch is on (in position I); if, even with the switch on, the control panel switches off immediately, the battery will have to be recharged.

Open panel (A) to reach the charger socket: put a finger in the hole and pull.

It takes about 8 hours to completely charge the battery; we suggest charging it over night.

Charger electrical specifications:

Input 100÷240 Vac 0,8 A 50/60 Hz

Output 15 V dc 24W $\ominus\text{---}\oplus$
Class II



WARNINGS

Only use devices that comply with applicable standards.

Do not use the equipment while the battery is recharging.

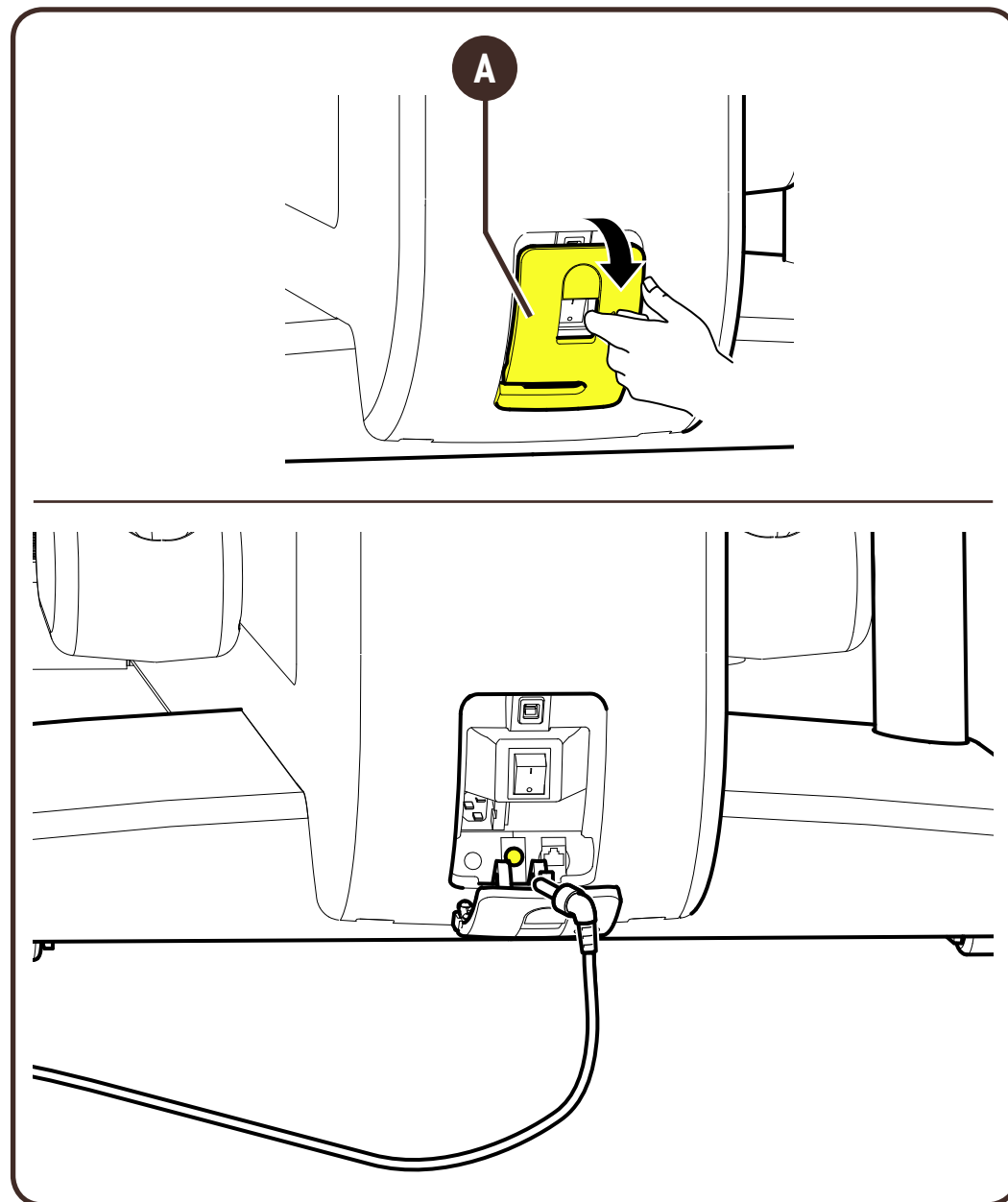

Troubleshooting

Below is a list of problems that may arise during normal use of the equipment. If the described remedies do not solve the problem, contact the Technical Support Service.

Problem	Cause	Remedy
Equipment doesn't switch on	Mains power failure (mains powered version).	Check the power supply at the wall socket used by the equipment by plugging in an appliance that definitely works.
	Power supply cable damaged (mains powered version).	Contact the Technogym Technical Support Service.
	Installation problems with the power supply cable (mains powered version).	Check the connection.
	Burnt-out fuses (mains powered version).	To replace the blown fuse with a spare contact Technogym Technical Support Service.
	The control panel connector has been accidentally disconnected.	Contact the Technogym Technical Support Service.
Too noisy	Equipment not properly levelled.	Check the position and level the adjustment feet.
	Damaged bearings.	Contact the Technogym Technical Support Service.
	Worn belt.	Contact the Technogym Technical Support Service.
Data incorrect or unreliable with equipment running	Equipment next to source of radio interference (e.g. electrical domestic appliances).	Move the equipment to another place or move the domestic appliances.

Troubleshooting

Problem	Cause	Remedy
Problems in monitoring heart rate with the chest band	Other transmitters situated nearby.	Move the equipment far enough away to stop signal interference (minimum distance between two units 80 cm).
	Strong interference sources nearby.	Find the interference source (e.g. an electrical domestic appliance) and move it away, or move the equipment.
	Worn heart rate monitor chest band.	Change the chest band.
	Chest band transmitter not making proper skin contact.	Dampen the inside of the chest band with water.
	Damaged transmitter.	Change the chest band.
Absence of braking in the Renew model	The Country has not been correctly set.	Check the Country setting, as described in the installation instructions.
Insufficient braking in the Renew product	Problems with the electric wiring system.	Have the wiring system checked by a qualified electrician.

Technical assistance

The Technogym Technical Support Service provides:

- telephone consultation
- information about which services are covered by the warranty and which must be paid for
- on-site servicing
- supply of original spare parts.

**Technical Support Service
Technogym s.p.a.**

**Via Calcinaro 2861, 47521 Cesena Italy
tel: +39 0547 56047
<http://www.technogym.com/Support>**

When you contact the Technogym Technical Support Service you must give the following information:

- model,
- date of purchase,
- serial number,
- precise description of the problem.



WARNING

Work on the equipment by persons unauthorised by Technogym invalidates the warranty.

Technogym supplies the electrical and wiring diagrams to companies with technical support.

Storage

If a long period of non-use is expected, you are advised to store the equipment in the following way:

- in a clean dry place, with a dust cover;
- at a room temperature between -10°C and 70°C and relative humidity between 20% and 90%.

For better storage, use the original packing materials.

Disposal

It is always good practice to ensure that the unit can never constitute a hazard; therefore do not leave the equipment where children may play with it. For this reason, when it is not used for long periods it must be turned off by disconnecting the power cable.

Do not dump the equipment in the environment, or in public or private areas accessible to the public.

The equipment is made from recyclable materials such as steel, aluminium and plastic, which must be disposed of in the manner required by the urban refuse collection regulations in force, by specialised urban hygiene and environmental firms.

Electrical and electronic waste must not be put out for normal waste collection. A specific waste collection system is provided for with this type of product, in conformity with applicable legislation requiring appropriate handling, recovery and recycling.

Unauthorised dumping or disposal of electrical and electronic equipment or improper use of the same can cause serious damage to the environment and human health.

Following measures implemented by the member states of the European Union, private citizens resident in the EC can take their used electrical and electronic equipment to authorised collection centres for disposal.

If the product is used commercially, contact your reseller or Technogym Customer Service in your country to arrange collection and disposal of the electrical or electronic waste.

Contact the local authorities for disposal of electrical or electronic waste in countries outside the European Union.

Average product lifetime: 10 years.

Disposal of the battery (battery-powered version)

The battery is made of non-recyclable materials: do not discard it in the environment.

Contact specialist urban and environmental cleansing agencies for disposing of the battery.

Switching on and off

To turn the mains powered version of the equipment on, switch the main switch to “I” (ON) position.

To turn the battery-powered version of the equipment on, start moving.

After a quick system check (reset), the equipment is ready for use.

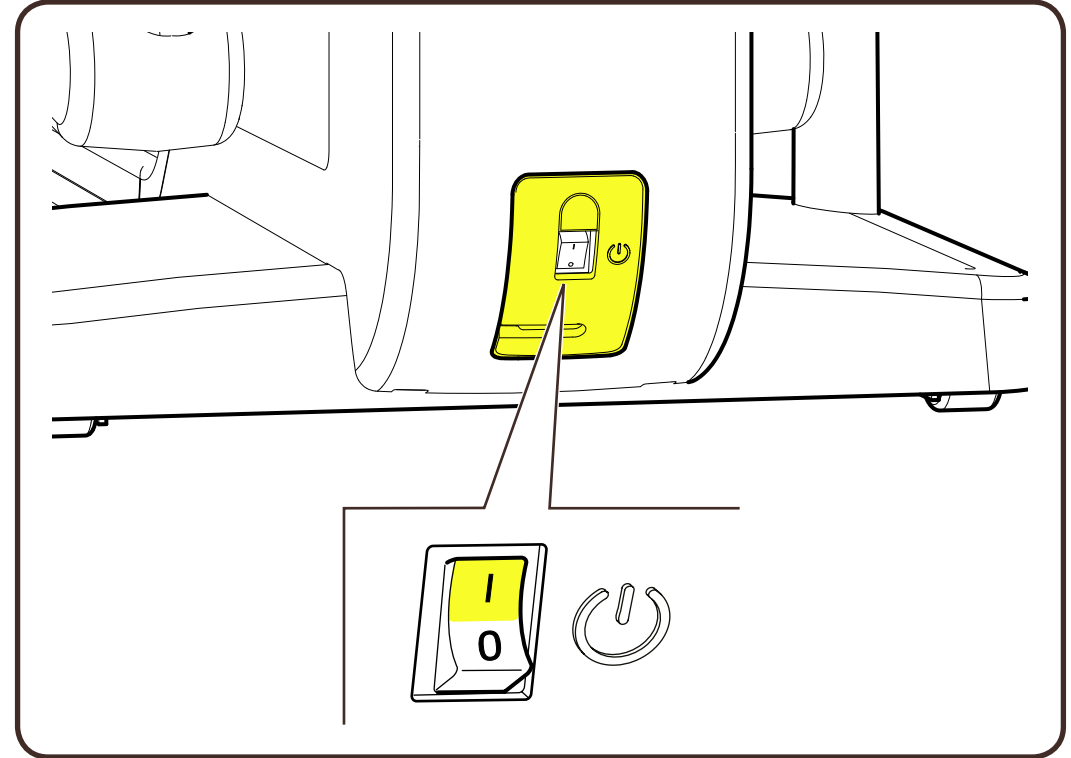

For the battery-powered version:

- if, when you stop the exercise, the control panel switches off without warning, check that the main switch is on (in position I); if, even with the switch on, the control panel switches off immediately, the battery will have to be recharged.
- if the control panel delays in starting from when you begin pedalling, verify the starting times set in the configuration menu (see the control panel user manual).

Switching on and off

To turn the mains powered version of the equipment off, switch the main switch to “0” (OFF) position.

The equipment must be switched off only at the end of the exercise, when in standby.

If the equipment isn't going to be used for a long time, as well as turning it off you should also pull the plug out of the wall socket.



WARNINGS

The switch is for turning the equipment on and off but does not isolate it completely from the mains voltage, even in the “0” position (off).

In both the mains powered version and in the battery-powered version, the power plug must be disconnected from the mains power supply to ensure that the equipment is fully isolated.

To turn the battery-powered version of the equipment off, just stop moving.

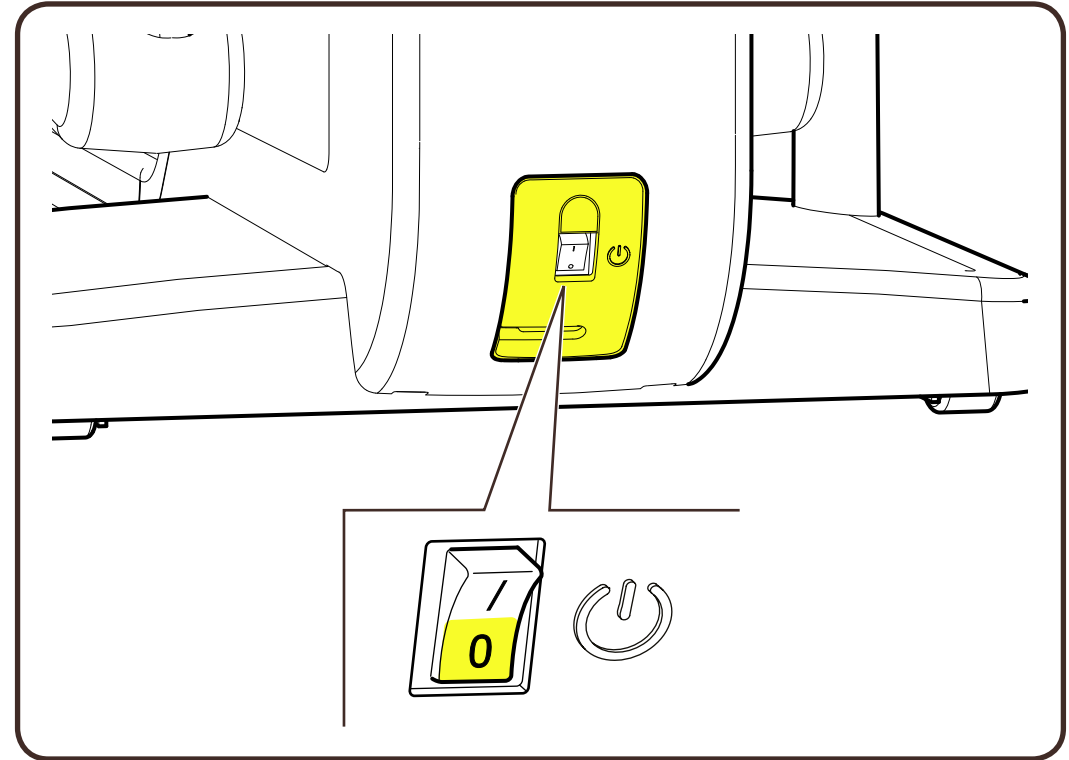

심박동수 측정의 정확 rate

장비인 심박동수 트랜스미터를 측정하는 방법의 두 가지 다른 방식:

- with a device fitted on the fixed handgrips and on the levers (hand sensor) which is activated simply by gripping the fixed handgrips or the levers in the area of the sensors;

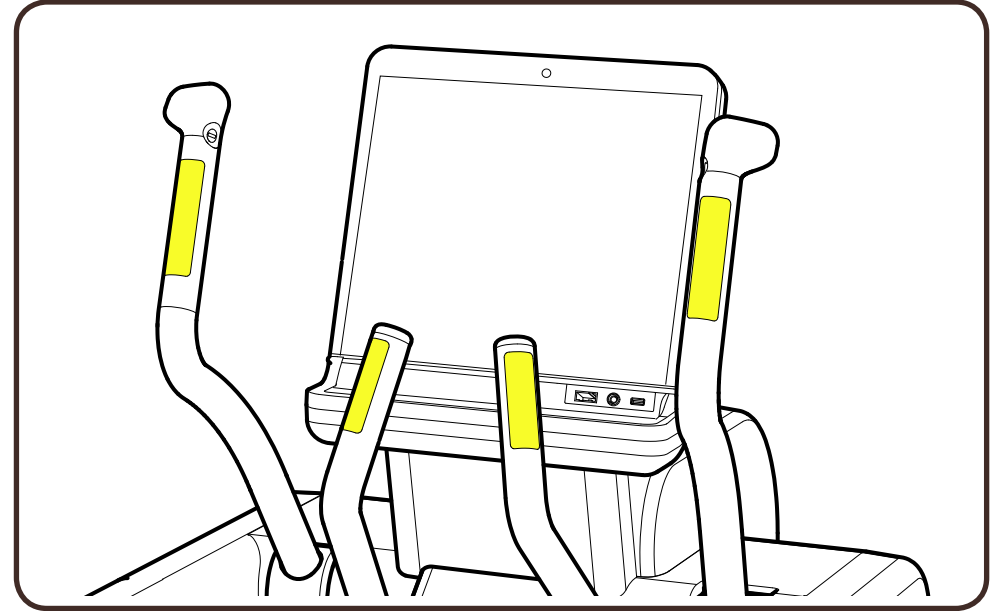

- 심박동수 트랜스미터(Polar H7)를 갖춘 체스트 밴드.
- with a chest band with a heart rate transmitter (Polar H7).

수신 범위 내에는 한 개 이상의 트랜스미터가 있으면 안 됩니다. 그렇지 않을 경우 리시버가 다른 신호를 동시에 받게 돼 심장 박동을 잘못 읽게 됩니다. 심장박동 리시버를 갖춘 장비가 같은 지역에 여러 개가 있다면, 장비 간의 거리를 최소한 80cm를 유지해야 합니다.

전자기 방사원(TV, 휴대폰 등)이 근처에 있을 경우, 심장 박동 측정이 부정확할 수 있습니다.

Heart rate readings will not be accurate near electromagnetic radiation sources (TV, mobile phones, etc.) Should you have any doubts about the accuracy of the readings, contact the Technical Support Service.

Should you have any doubts about the accuracy of the readings, contact the Technical Support Service.

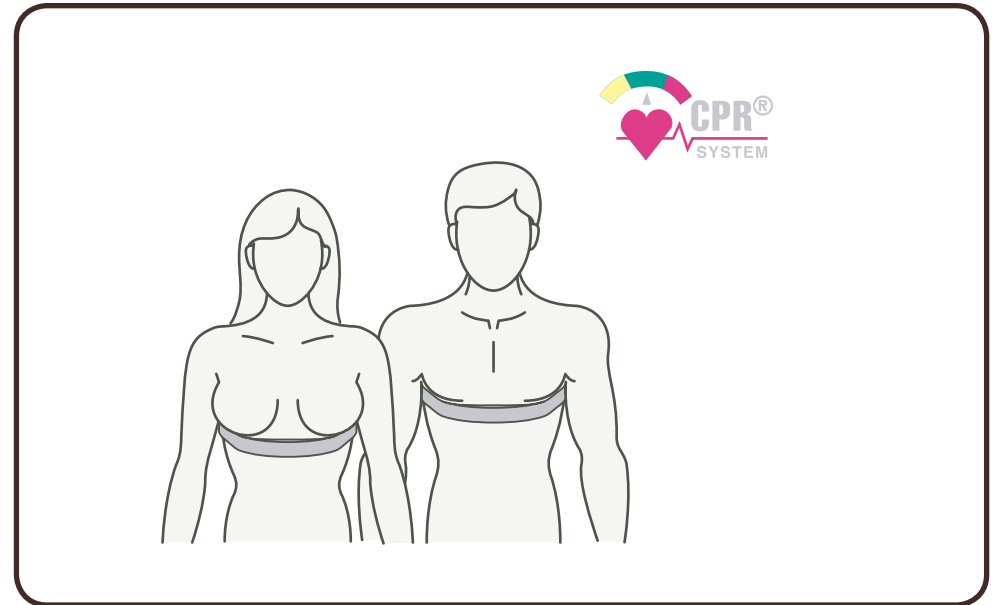

Monitoring the heart rate

The table shows the optimum heart rate levels in relation to age and the goal to be achieved.

Theoretical maximum heart rate (100%) is calculated on the basis of age using the formula: $\text{max H.R.} = 220 - \text{age}$.





To read the graph, simply find your age on the horizontal axis and scan up the vertical until you reach the 60%, 70% and 90% values.

Aerobic exercise performed at a heart rate **between 60% and 70%** mainly burns fat as an energy source.

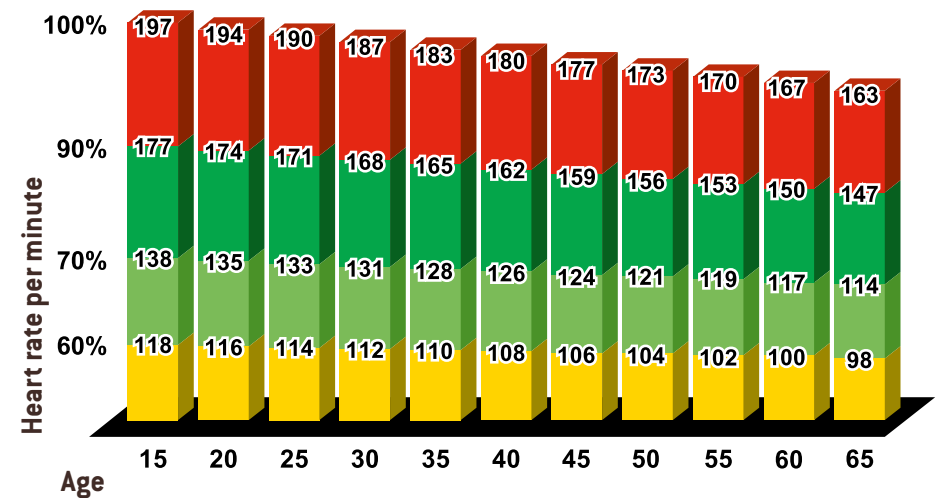
When doing aerobic exercise at a heart rate of **70% to 90%** the cardiocirculatory component prevails.

For example, if someone **aged 30** wants to burn off fat, the heart rate during exercise should be kept to between 112 (60%) and 131 (70%); if he or she wants to improve cardio-respiratory capacity, the heart rate should be kept to between 131 (70%) and 168 (90%).



-  Area reserved for competitive athlete's workouts (requiring a doctor's certificate)
-  Aerobic zone with a primarily cardio-circulatory component (keep heart rate between 70% and 90%)
-  Aerobic zone primarily using fats as energy source (keep heart rate between 60% and 70%)
-  Zone of little training interest



WARNINGS

During a workout it is very important that your heart rate never goes above 90% of your maximum rate (unless you are an athlete engaged in competitive sport).

The sole function of the heart rate monitor is to display the heart rate during exercise and cannot be used for medical cardiac diagnoses of any kind. The heart rate shown on the display is purely indicative and cannot be considered absolutely certain.

Using the equipment

Grip the side support to climb onto the equipment.

Get on the platform that is in the lowest position and then place one foot on each platform.

While setting the exercise on the control panel with one hand, hold onto one of the fixed handgrips with the other.

To perform movements only with your legs, hold onto the fixed handgrips; to perform movements with your arms too, take hold of the levers.

Initially push the platforms downwards, then gradually lengthen your stride until you find the most pleasant and natural movement.

Vario makes it possible to adapt the movement of the equipment to the height and preferences of the user: from vertical step to a fast walk or a steady run.

The length of the pace varies from 0 to 83 cm, for total freedom of movement.



Using the equipment

At the beginning move slowly until you become familiar with the equipment and acquire balance. It is important that you move without leaning forward and assuming unnatural positions.

Once you become more confident, gradually increase the effort level.

Constantly check your position: head held high, shoulders in line with the hips, abdomen sucked in and trunk erect. To maintain correct posture you must keep legs and feet parallel and gaze straight ahead.

The intensity of the exercise can be adjusted not only by pressing the buttons on the control panel, but also with the Fast Track controls on the levers.



WARNINGS

Any distractions in the area around the equipment may cause the user to lose his/her balance.

Get on and off the equipment only when the platforms have stopped moving.

Vario is to be used solely for its intended purpose, i.e. for aerobic exercise of the legs and arms. Any other use is considered unauthorised and therefore dangerous.



Vario Artis_uk_AD
OSM00829



The Wellness Company